

1-Line, Bi-directional, Transient Voltage Suppressors

Descriptions

The ESD5A005TA is a bi-directional TVS (Transient Voltage Suppressor). It is specifically designed to protect sensitive electronic components that may be subjected to ESD (Electrostatic Discharge), EFT (Electrical Fast Transients) and Lightning. It is particularly well-suited for cellular phones, portable device, digital cameras, power supplies and many other portable applications because of its small package and low weight.

The ESD5A005TA may be used to provide ESD protection up to $\pm 30\text{kV}$ air discharge $\pm 30\text{kV}$ contact discharge according to IEC61000 - 4 - 2, and withstand peak pulse current up to 13A (8/20 μs) according to IEC61000-4-5.

The ESD5A005TA is available in SOD-323 package. Standard products are Pb-free and Halogen-free.



SOD-323

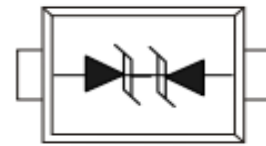

Circuit diagram

Features

- Stand-off voltage: $\pm 5\text{V}$ Max
- Transient protection for each line according to IEC61000-4-2 (ESD): $\pm 30\text{kV}$ air discharge $\pm 30\text{kV}$ contact discharge IEC61000-4-5 (surge): 13A (8/20 μs)
- Solid-state silicon technology

Applications

- Cell phone handsets and accessories
- Personal Digital Assistants (PDAs)
- Notebooks, Desktops, and Servers
- Portable Instrumentation
- Digital Cameras
- MID/CAR DVD/MP3/MP4/PMP Players

Order information

Device	Package	Shipping	Mark
ESD5A005TA	SOD-323	3000/Tape&Reel	AC

Absolute maximum ratings

Parameter	Symbol	Rating	Unit
Peak pulse power ($t_p = 8/20\mu s$)	P_{pk}	230	W
Peak pulse current ($t_p = 8/20\mu s$)	I_{pp}	13	A
ESD according to IEC61000-4-2 air discharge	V_{ESD}	± 30	kV
ESD according to IEC61000-4-2 contact discharge		± 30	
Operation junction temperature	T_J	-55~150	$^{\circ}C$
Lead temperature	T_L	260	$^{\circ}C$
Storage temperature	T_{STG}	-55~150	$^{\circ}C$

Electrical characteristics (TA=25 $^{\circ}C$, unless otherwise noted)

Parameter	Symbol	Condition	Min.	Typ.	Max.	Unit
Reverse stand-off voltage	V_{RWM}				± 5	V
Reverse leakage current	I_R	$V_{RWM} = 5V$			0.1	μA
Reverse breakdown voltage	V_{BR}	$I_T = 1mA$	7.0	7.5		V
Clamping voltage	V_C	$I_{pp} = 1A$ $t_p = 8/20\mu s$		9.0	10.0	V
		$I_{pp} = 13A$ $t_p = 8/20\mu s$		16.0	18.0	V
Junction capacitance	C_J	$V_R = 0V$, $f = 1MHz$		1.0	1.5	pF

Electrical performance curve

V_C : Maximum clamping voltage

V_{br} : Reverse breakdown voltage

V_{RWM} : Working voltage

I_{pp} : Maximum peak current

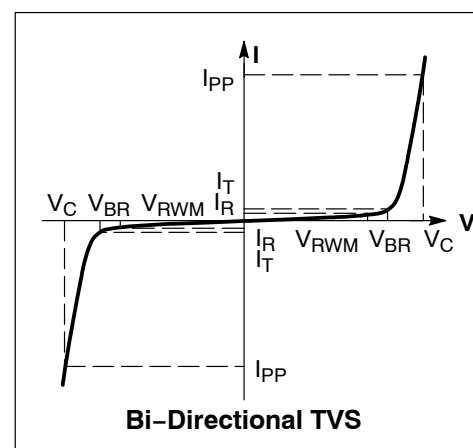

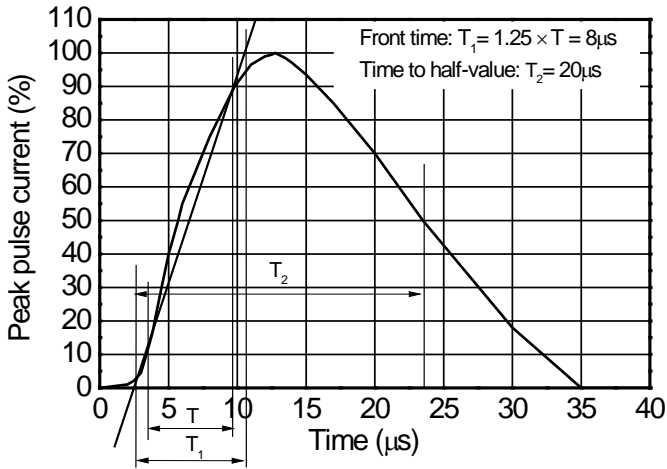

8/20 μs waveform per IEC61000-4-5

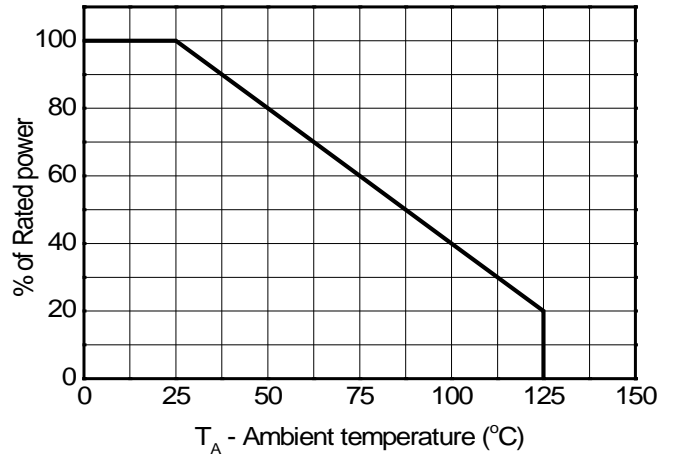

Power derating vs. Ambient temperature

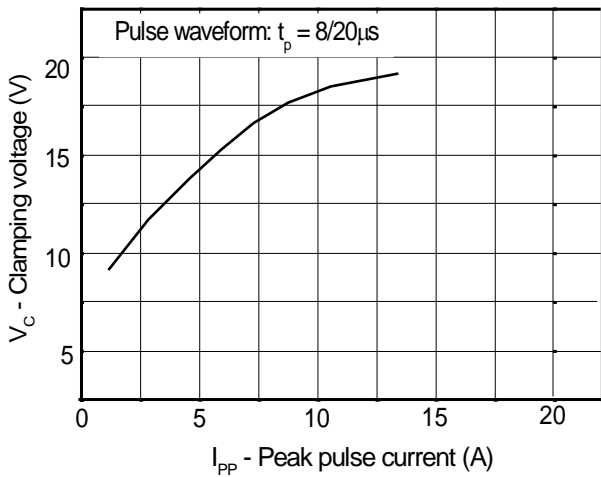

Clamping voltage vs. Peak pulse current

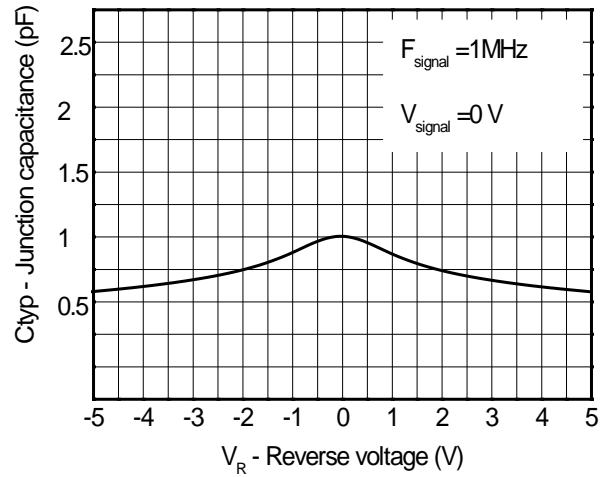

Capacitance vs. Reverse voltage

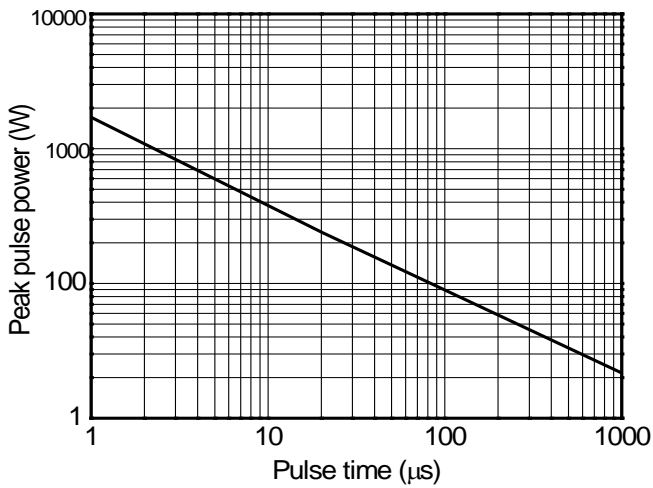

Non-repetitive peak pulse power vs. Pulse time

ESD clamping test setup and waveforms

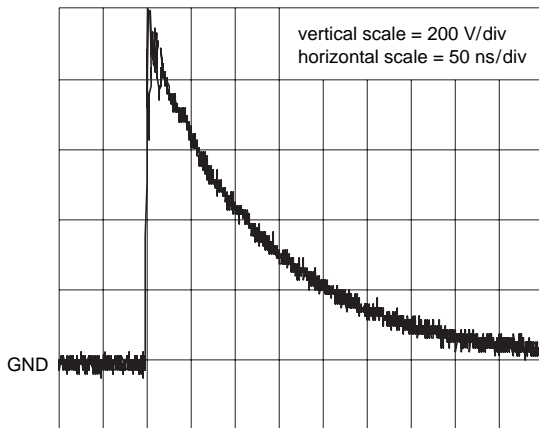
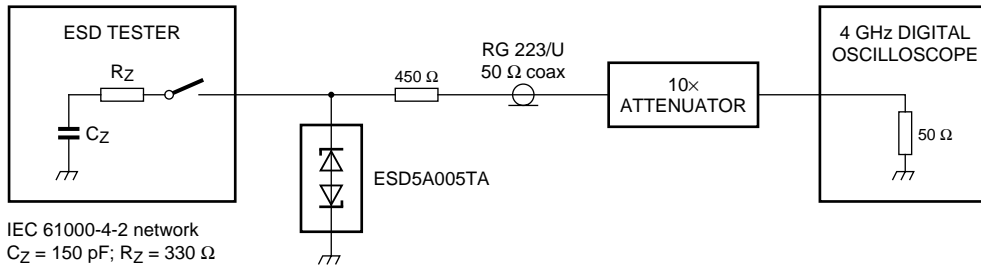

unclamped +1 kV ESD voltage waveform
(IEC61000-4-2 network)

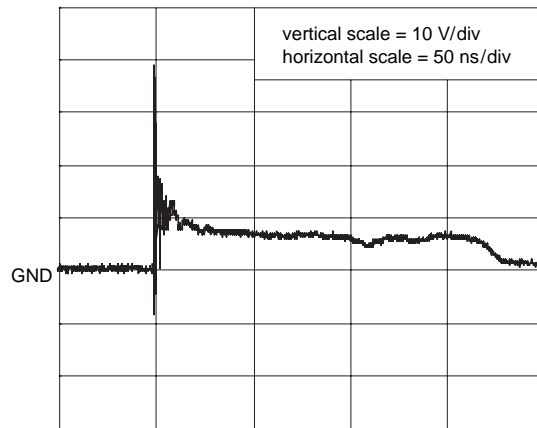

clamped +1 kV ESD voltage waveform
(IEC61000-4-2 network)

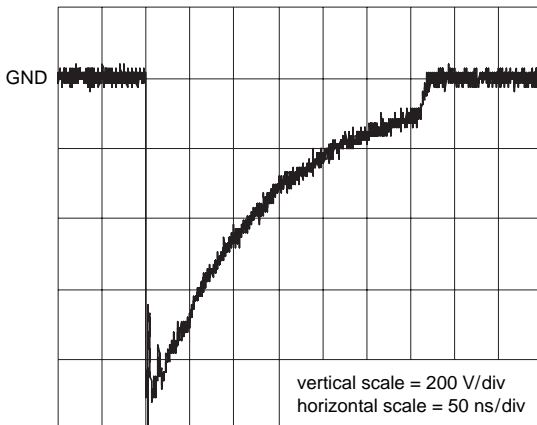

unclamped -1 kV ESD voltage waveform
(IEC61000-4-2 network)

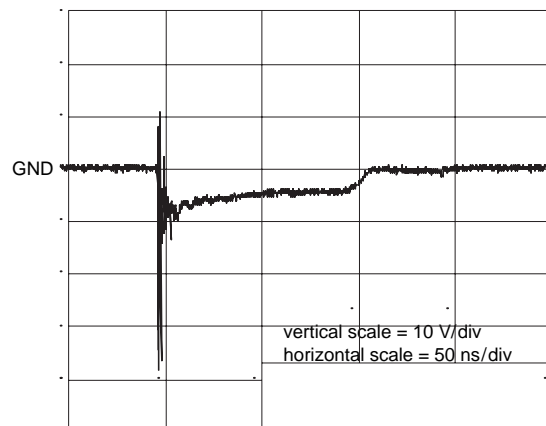

clamped -1 kV ESD voltage waveform
(IEC61000-4-2 network)

Package outline dimensions

SOD-323

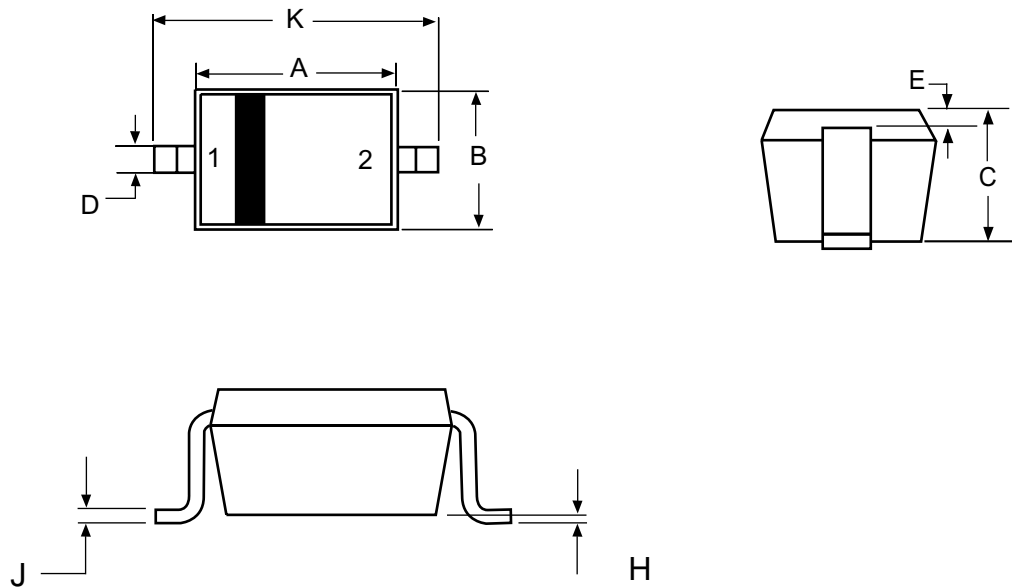

Symbol	Millimeter		Inches	
	Min.	Max.	Min.	Max.
A	1.60	1.80	0.063	0.071
B	1.15	1.35	0.045	0.053
C	0.80	1.00	0.031	0.039
D	0.25	0.40	0.010	0.016
E	0.15 REF		0.006 REF	
H	0.00	0.10	0.000	0.004
J	0.089	0.177	0.0035	0.0070
K	2.30	2.70	0.091	0.106

Recommend land pattern (Unit: mm)

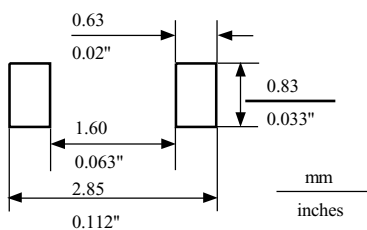

Note: This land pattern is for your reference only. Actual pad layouts may vary depending on application.